

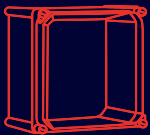

EUROPOLY

  **MADE IN FRANCE**

THE POLYESTER REFERENCE



MICRO EURO

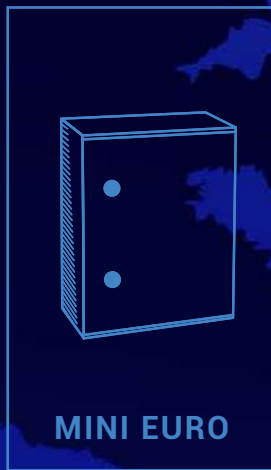

MINI EURO



EURO MEDIUM

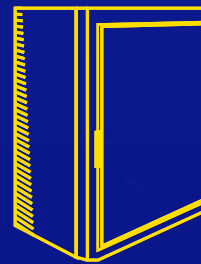

MAXI EURO 1500

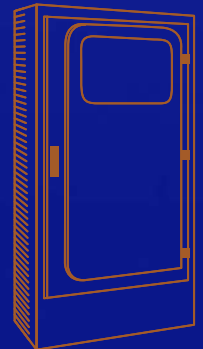

MAXI EURO 1900

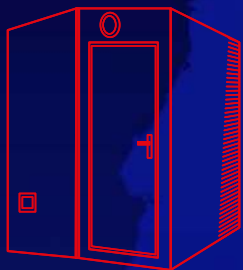

MEGA EURO

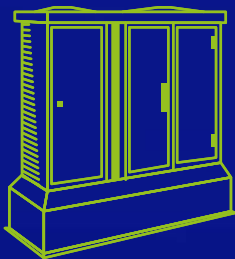

EURO URBAIN



EURO INSTRUM



CUSTOM-MADE

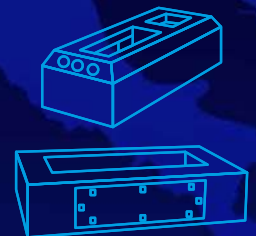

ACCESSORIES



GENSOLLEN

COMPANY FROM EUROPOLY GROUP

MINI EURO

STANDARD CABINETS
from 300 x 250 x 160
to 1000 x 800 x 340 mm



Ref.	Dir
Solid door	Height
030202	300
040302	400
050402	500
060502	600
080603	800
081003	800
100803	1000

Ref.	Dir
Solid door	Height
030202	300
040302	400
050402	500
060502	600
080603	800
081003	800
100803	1000

SPECIAL FEATURES THAT MAKE THE DIFFERENCE

- Door frame edging solely on left and right sides: increased cabling area.
- No lateral supports: increased cabling and drilling areas, as well as possibility for cut-outs on the sides.
- Fittings at the back of the cabinet for direct attachment of a DIN rail.
- Mounting brackets provided with every cabinet at no extra cost.

PROTECTION DEGREE IP66 / MECHANICAL IMPACT

RESISTANCE IK10

Cabinets specifically used to house electrical and electronic equipment in a corrosive environment. These cabinets are adapted for a range of uses and suit damp and corrosive environments both indoors and outside.

EXTREMELY RESISTANT TO CORROSION





Dimensions in mm		Mounting plate			Door window	Notched bars	Modular frame
Width	Depth	Full galvanised steel	Perforated galvanised steel	GRP			
250	160	PEM 0302	PEF 0302	PEP 0302	030303T	/	/
300	200	PEM 0403	PEF 0403	PEP 0403	040302T	PDP 200	CH 43
400	200	PEM 0504	PEF 0504	PEP 0504	050402T	PDP 200	CH 54
500	250	PEM 0605	PEF 0605	PEP 0605	060502T	PDP 250	CH 65
600	300	PEM 0806	PEF 0806	PEP 0806	080603T	PDP 300	CH 86
1000	340	PEM 0810	PEF 0810	PEP 0810	081003T	/	/
800	340	PEM 1008	PEF 1008	PEP 1008	100803T	/	/

Dimensions in mm		GRP cable entry plate	Key lock	Air grid	Pole fixing	32m stainless steel tape
Width	Depth					
250	160	PPC 0302	CL 1/..	DRG	FIX 0302	ROL 32
300	200	PPC 0403	CL 2/..	DRG	FIX 0403	ROL 32
400	200	PPC 0504	CL 2/..	DRG	FIX 0504	ROL 32
500	250	PPC 0605	CL 2/..	DRG	FIX 0605	ROL 32
600	340	PPC0806	CL 2/..	DRG	FIX 0810	ROL 32
1000	340	PPC 0810	CL 2/..	DRG	FIX 0806	ROL 32
800	340	PPC 1008	CL 2/...	DRG	/	/



MINI EURO

STANDARD CABINETS FROM 300 X 250 X 160 TO 1000 X 800 X 340 MM

MINI EURO

STANDARD CABINETS
from 300 x 250 x 160
to 1000 x 800 x 340 mm

Standard Mini Euro cabinets are provided with 2 "double bar" locks
(except ref. 030202 : 1 lock)
with the option to install any Ronis key locking system (eg. 1242E, 405, 455 etc.).

GRP awning
to avoid standing
water above the
door.

Insert and fittings: choose from different
assembly methods at the back of the cabinet.
4 M6 pins for the installation of a frame,
mounting plate with cap screw fittings to be
directly attached to a DIN rail.

**Polyurethane
watertight sealant**
fitted directly to
the door.

**Space for
installation of
insters** on the
door, allowing
rapid assembly of
equipment.

**¼ turn double bar
locking system**

**Grid pattern
on the door** to
facilitate marking
and drilling.



Standard delivery
includes a set of **4
swivelling mounting
brackets** at no extra
cost.

Cast aluminium hinges
eparate from the watertight
area of the cabinet. 2 hinges
provided for cabinets' ref:
030202, 040302, 050402
and 3 hinges provided for
cabinets' ref: 060502, 080603.
Doors open to 180°.

OPTIONS +



TECHNICAL FEATURES

- Fibre-glass reinforced polyester cabinet
- Double insulated cabinet (classe II)
- Protection degree IP 66 (suivant norme EN 60529)
- Mechanical impact resistance IK 10 (complying with EN 62262 standard)
- Electrically insulating material
- Moisture resistant material
- Resistant to extreme temperatures (from -30° to + 120° C)
- Colour RAL 7035
- Reversible cabinet : opening on left or right sides

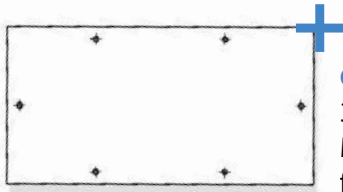

GRP cable entry plate: According to the dimensions of the cabinet, 3 sizes of cable entry plate are offered. Made out of GRP polyester, drilled and delivered with screws and plugs for installation at the bottom of the cabinet.



Pole fixing: 2 hot dipped galvanised steel fastenings allowing you to attach the cabinet to a beam, post or pole. Optional: stainless steel strip and tools to adjust and cut.

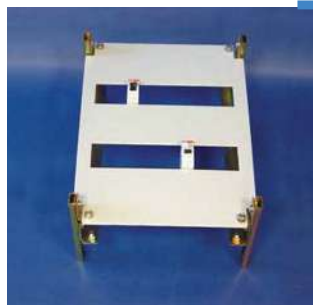

Modular frame: Consisting of DIN rail, installation system, stitched GRP face-plate. All of our modular frames are adjustable in terms of depth.



Notched bars: System using 4 C-type profiles to be installed on both sides of the cabinet, allowing you to adjust the position of the mounting plate depth-wise.



Door window: Anti-UV, anti scratch polycarbonate window. A double-lip sealant maintains the visual through the door whilst also maintaining the waterproofing of the cabinet.



Insulating GRP



Full sheet galvanised steel



Micro-perforated galvanised steel

We offer 3 types of mounting plate: full sheet galvanised steel, perforated galvanised steel and full sheet GRP.

MINI EURO

STANDARD CABINETS
DIMENSIONS

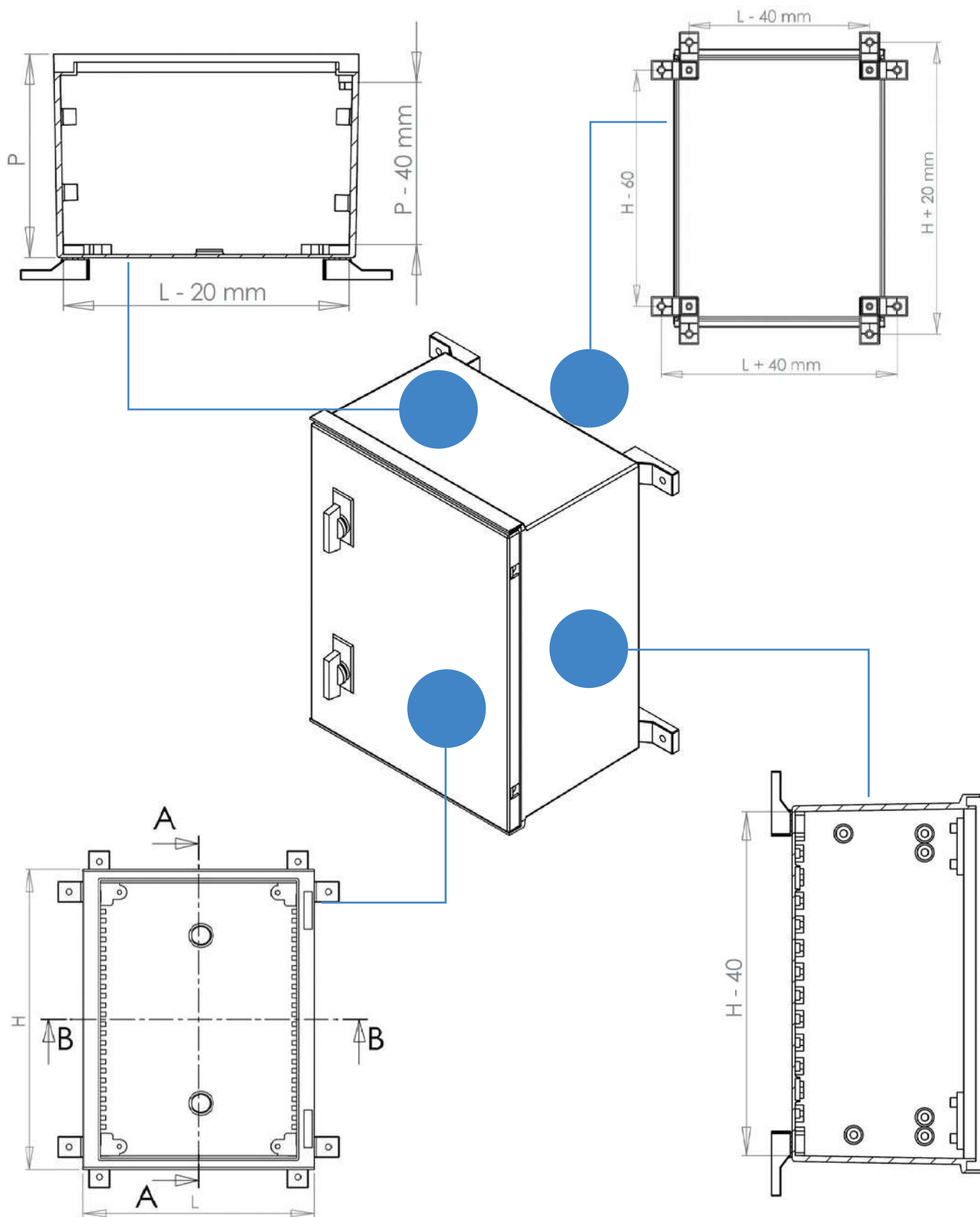

COUPE A-A



MOUNTING PLATE

Ref.	30202	40302	50402	60502	80603
A	254	359	461	555	754
B	233	338	440	536	735
C	213	260	360	451	555
D	157	210	310	406	505

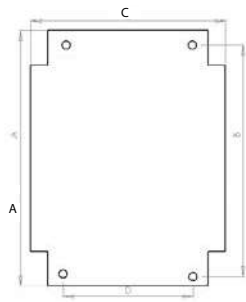

Full mounting plate

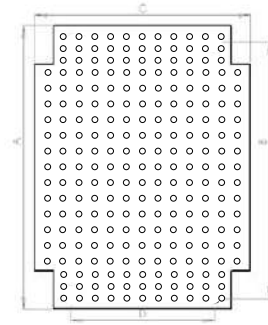

Micro-perforated mounting plate

MODULAR FRAME

Ref.	30202	40302	50402	60502	80603
Number of rows	-	2	3	3	4
Number of units per row	-	12	18	23	29
Total number of units	-	24	54	69	116

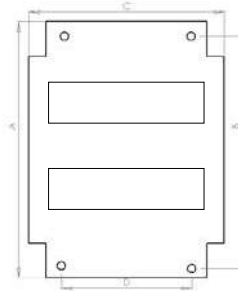

CABLE ENTRY PLATE

Ref.	Plate dimensions in mm	
	L	P
30202	170	100
40302	220	140
50402	350	140
60502	550	190
80603	550	190

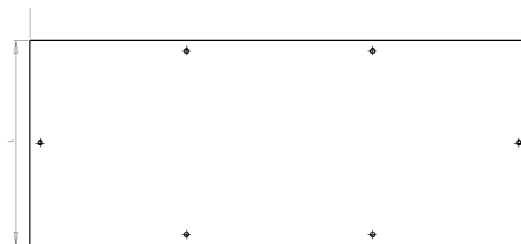

DOOR WINDOW

Ref.	Window dimensions	
	L	P
30202	126	74
40302	226	126
50402	326	226
60502	426	326
80603	576	376

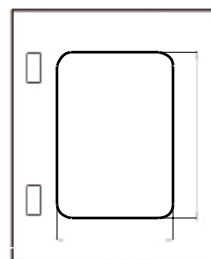



EUROPOLY

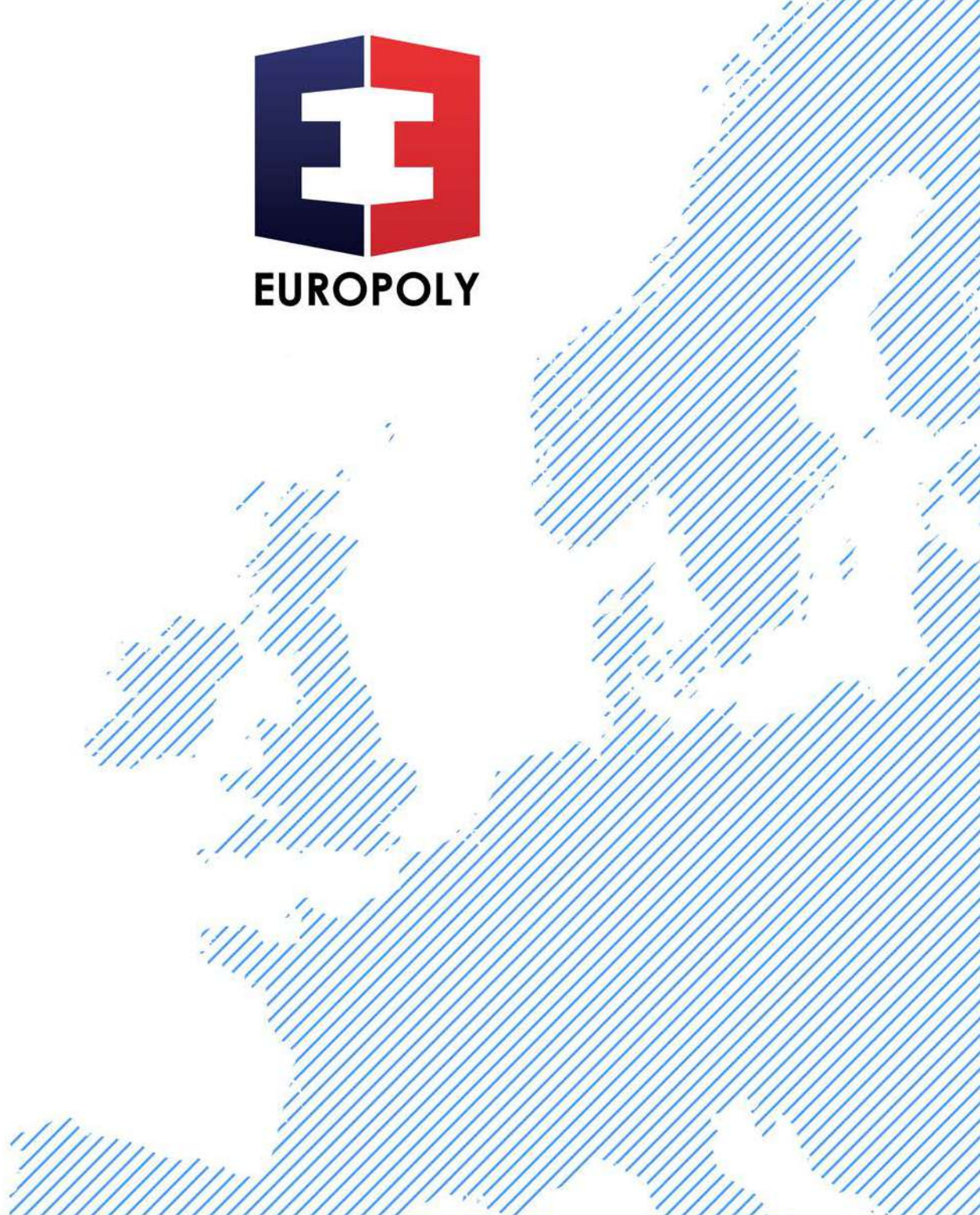

**PARC D'ACTIVITÉS DES PLATIÈRES
RUE DE LA GARENNIÈRE
69440 MORNANT - LYON
FRANCE**

+ 33 (0)4 78 19 33 33

Fax : + 33 (0)4 78 19 33 34

info@europoly.com

 Made in France

WWW.EUROPOLY.COM